

SPICE thermal model

BUK654R6-55C

Symbol	Parameter	Conditions	Min	Typ	Max	Unit
$R_{th(j-mb)}$	thermal resistance from junction to mounting base		-	-	0.74	K/W

C_{th1}	2.480E-01 F
C_{th2}	2.300E-02 F
C_{th3}	3.726E-03 F
C_{th4}	6.145E-04 F
C_{th5}	1.013E-04 F
C_{th6}	1.671E-05 F
C_{th7}	2.756E-06 F
C_{th8}	4.546E-07 F
R_{th1}	4.030E-01 Ω
R_{th2}	2.260E-01 Ω
R_{th3}	7.000E-02 Ω
R_{th4}	2.200E-02 Ω
R_{th5}	6.687E-03 Ω
R_{th6}	2.069E-03 Ω
R_{th7}	6.400E-04 Ω
R_{th8}	1.980E-04 Ω

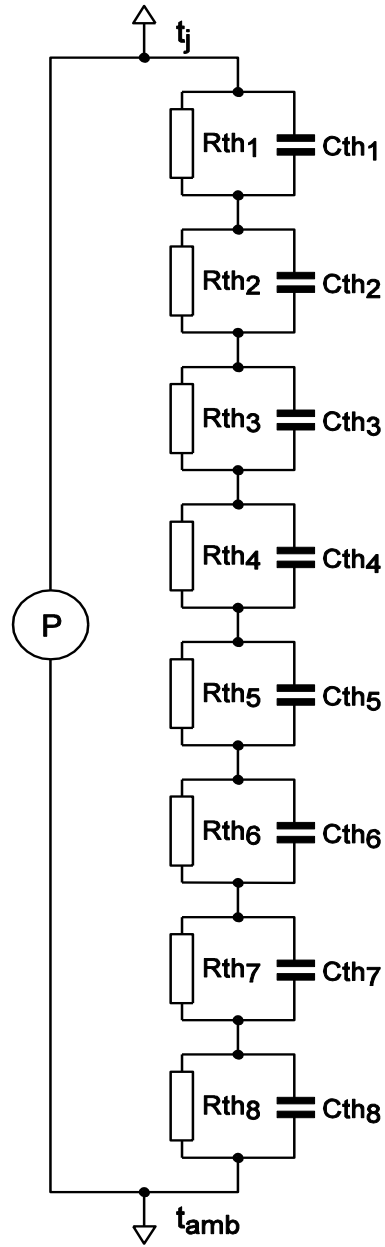

001aal768

Part: BUK654R6-55C
 Version: 1
 Date: 7-7-2010
 Rth: 0.735337816